

Products > Jewel Bearings > Cup Jewel Bearings > C3.00

Cup Jewel Bearings - C3.00

Specifications

Model	C3.00
Outside Diameter	.117/ .118"
Thickness	.060/ .064"
Radius	.052/ .057"
Depth	.023/ .027"
Type	Cup Jewel



Custom Options Available

Description

A cup jewel is generally used with a semi-spherical pivot or in a design that fits a ball bearing between two cup jewels. Cup jewels are widely used for vertical shaft applications.

Typical Applications

- Meters
- Compasses
- Heat Monitors

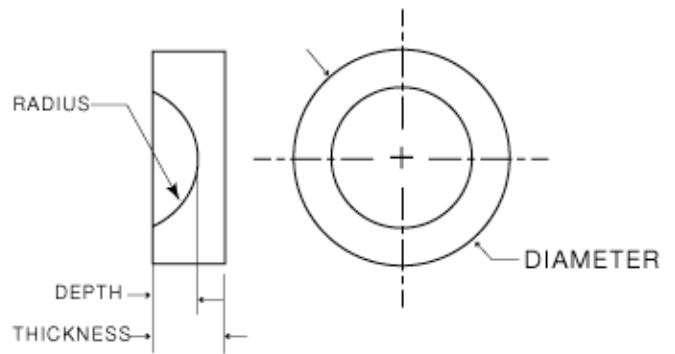

NOT SEEING EXACTLY WHAT YOU NEED?

We at the Swiss Jewel Company specialize in creating a wide range of custom optical components and custom mechanical components including a variety of shapes - from internal holes and tapers to outer flanges, angles and surface finishes. Contact us and we will consult with you to create a custom component that meets all of your specifications.